

FLEX CHECK® - High Performance Insert Check Valve

DATA SHEET FORWARD FLOW CHECK VALVE FF055-040

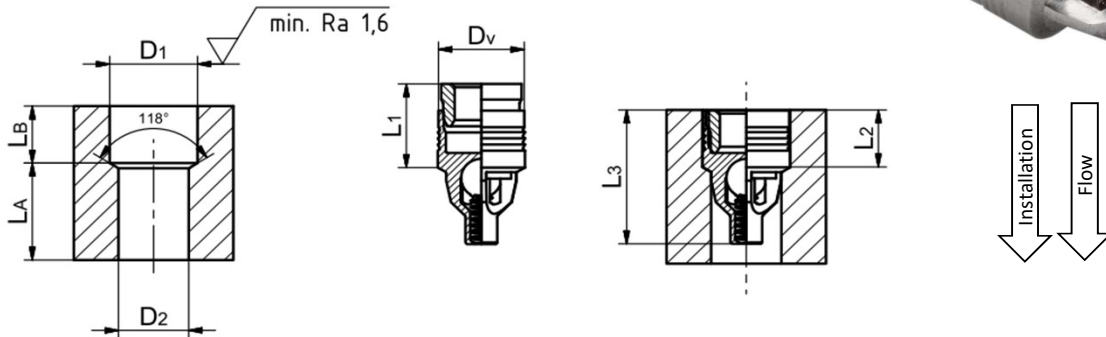

Dimensions



Bore Hole		mm
D1	Hole Diameter Down Stream	5.6+/-0.05
D2	Hole Diameter Up Stream	4.5
Lb	Min. Hole Length Upstream	3.9
La	Min. Hole Length Downstream	4.8

Valve		mm
Dv	Valve Diam.	5.48+/-0.02
L1	Length Pin pre-assembled	5.4
L2	Length installed Upstream	3.9+/-0.05
L3	Length installed total	8.7

Installation

- 1 Drill bore hole according dimensional drawing above
- 2 Set Flex Check Valve into bore hole.
- 3 Push in Pin by the indicated distance (L-Push-In) with Installation Tool and appropriate table press.

Max. Installation Force	L-Push-in (mm)
<7 KN	1.6

Performance

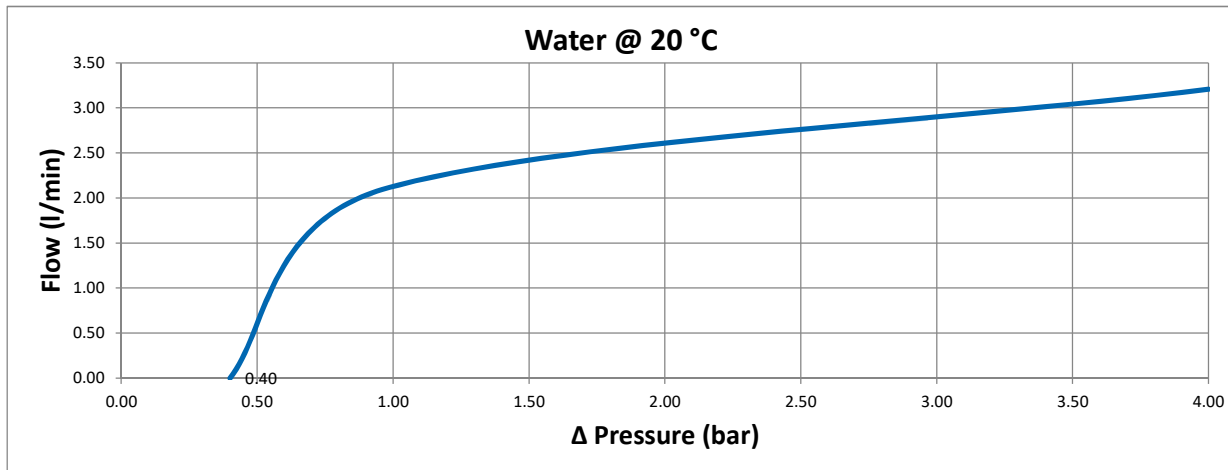

Cracking Pressure	bar	0.40 +/-30%
Leakage	sccm/min	<5
Working Pressure - checked/flow	bar	400/40
Max. Installation Force	KN	<7
Min. Fixation Loading	KN	3.0
Life Time Cycles	cycles	15 mio
Weight	g	1.4

Materials

Body	Stainless Steel
Ball	Stainless Steel
Spring	Stainless Steel

Available Options

/Rxyz	Restrictor Orifice (xyz=Diameter in 1/10 mm)
/S125	125 mcr Screen
/C	Ceramic Ball
/H	High Flow Option
/P	High Accuracy Cracking Pressure +/- 10%
/Z	Zero Leak Type
/L	Light Version with reduced Inst. Force